



COMPANION

TRUSTED SINCE 1941

POWER COOKER & STOCKPOT SET

85,300 BTU



OUTDOOR USE ONLY

OWNERS MANUAL

Part No. COMP7012

COMP7012_COMP7012_Power Cooker & Stockpot_Manual_V1_FA_1903.indd 1

19/3/19 12:40 pm

IMPORTANT: PRINT SPECS

NUMBER OF COLOURS TO PRINT **4**

■ CYAN ■ MAGENTA ■ YELLOW ■ BLACK

■ COMPANION BLUE:
PANTONE 4-Colour Process Ref: DS 221-1 C
C100 M35 Y0 K0

DO NOT ALTER ARTWORK/DIELINE

DO NOT CHANGE DIELINE OR ARTWORK
不要更改DIELINE或ARTWORK

PLEASE PROVIDE PAPER PROOF
请提供纸张证明



IMPORTANT: Read these instructions for use carefully. Familiarise yourself with the appliance before connecting it to its gas container. Keep these instructions for future reference.

GENERAL WARNINGS

This appliance shall only be used with a LPG refillable gas cylinder certified to AS 2469 which has a Type 21 POL fitting designed to comply with AS 2473.

IT MAY BE HAZARDOUS TO ATTEMPT TO FIT OTHER TYPES OF GAS CONTAINERS.

ONLY USE IN WELL-VENTILATED AREAS.

CARBON MONOXIDE HAZARD - USING THIS APPLIANCE IN AN ENCLOSED SPACE MAY CAUSE DEATH. DO NOT USE IN CARAVANS, TENTS, MARINE CRAFT, CARS, MOBILE HOMES OR SIMILAR LOCATIONS.

WARNING! USE OUTDOORS ONLY.

CAUTION: accessible parts may be very hot. Keep young children away.

SAFETY INFORMATION

Inspect the appliance regularly for signs of wear, leaks or incorrect operation. If symptoms such as flaring of the burner, issues with lighting, damages to hoses or connections or leaks from seals or gas controls are identified do not attempt to repair, return to your authorised stockist for service and maintenance.

Do not modify this appliance.

Check that seals between the appliance and the gas container are in place and in good condition before connecting the gas container. See figure 1.

Do not use this appliance if it has damaged or worn seals.

Do not use the appliance if it is leaking, damaged or does not operate properly.

This appliance is to be operated on a stable, horizontal, non-flammable surface.

The appliance should be protected from direct drafts and in a well ventilated place.

Gas orifices and burner must be kept clear of dirt and cobwebs. Flow of combustion and ventilation air through the perforated portions of the appliance must not be obstructed.

Any cleaning agent used on the appliance must be of a non-combustible and non-corrosive nature.

Gas containers shall be changed in a well-ventilated location, preferably outside, away from people and any source of ignition, such as naked flames, pilot flame, electric heaters/equipment.



CARBON MONOXIDE HAZARD

**Using this appliance in an enclosed space may cause DEATH.
Do not use in caravans, tents, marine craft, cars, mobile homes
or similar locations.**

Only use the hose assembly supplied with this appliance for connection to the cylinder - DO NOT USE ADAPTORS.

Do not use hoses with a length greater than 1200mm.

Return to your place of purchase for spare parts, service and repair.

This appliance must only be serviced by an authorised person.

This appliance must be operated away from any flammable material or surfaces and materials.

Always operate appliance a minimum of 1000mm from flammable materials, walls and ceiling.

Ensure all packaging is removed prior to use.

Do not operate this appliance before reading the instruction booklet.

Do not place articles on or against this appliance.

Do not store chemicals or flammable materials, or spray aerosols near this appliance.

Do not operate with panels, covers or guards removed from this appliance.

Do not operate in an enclosed area without ventilation.

Do not operate in a boat, caravan or tent.

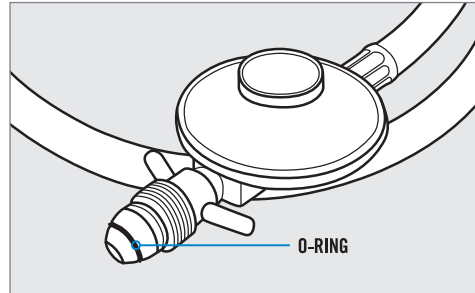
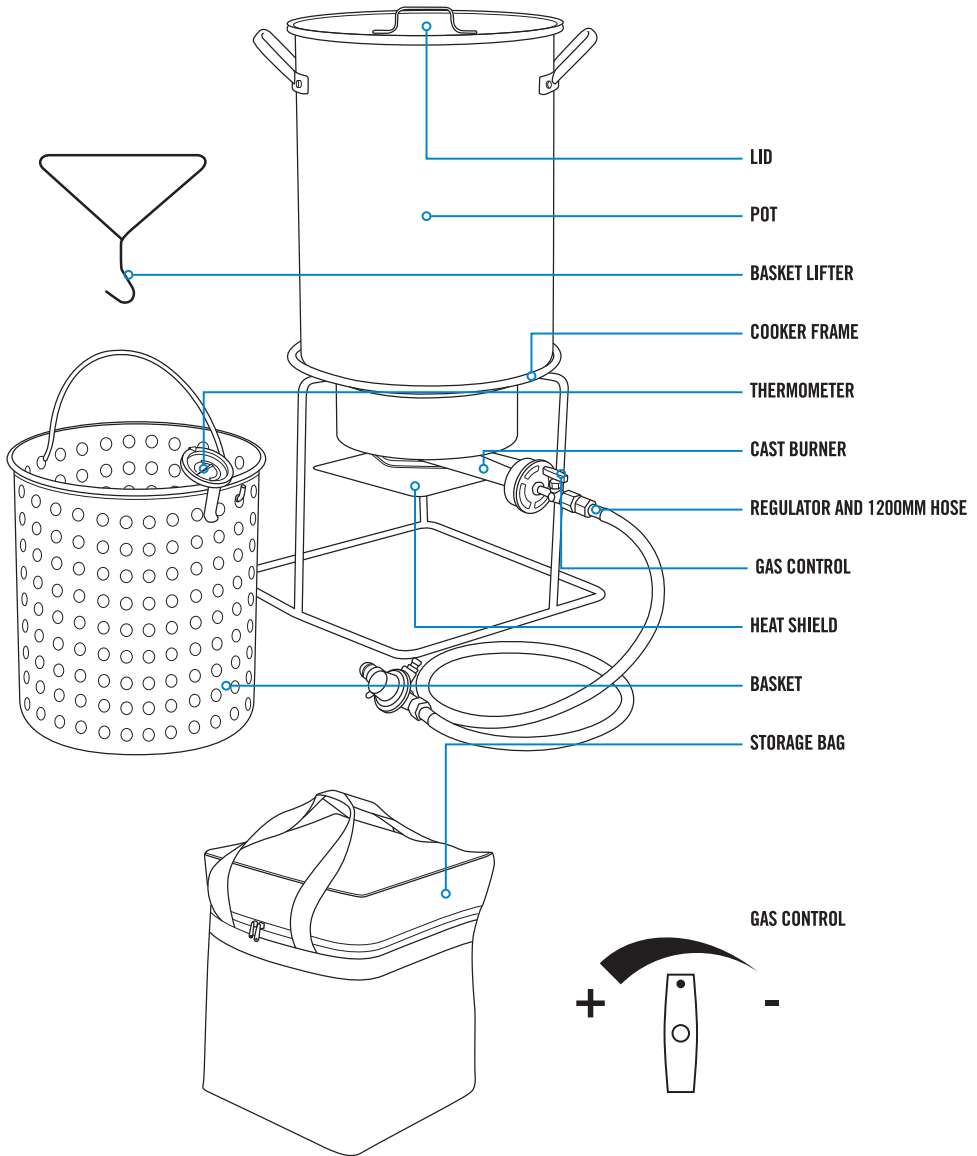

Figure 1: O-RING seal on the POL regulator.



UNDERSTANDING YOUR APPLIANCE





ASSEMBLY

Step 1. Install the burner and heat reflector into the steel frame, using the wing nut.

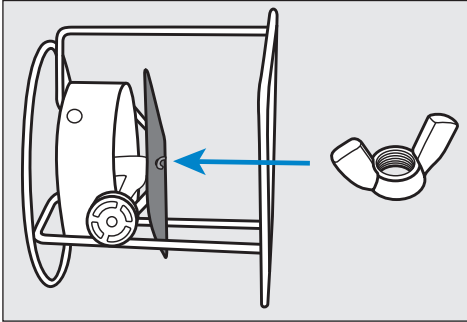

Step 3. Use an adjustable spanner to tighten. Take care not to overtighten as this will strip the thread in the burner tube

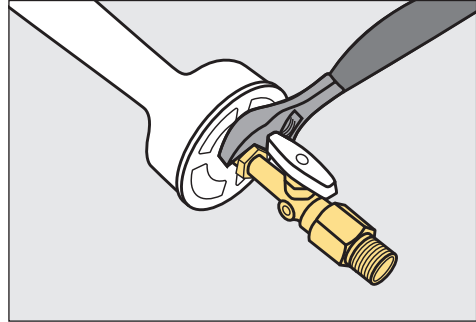

Step 2. Align the male end fitting on the Gas Control Assembly to the venturi tube on the burner and screw into the internal thread on the burner.

Note: Once connected, the gas control does not need to be removed for storage or when packed away.

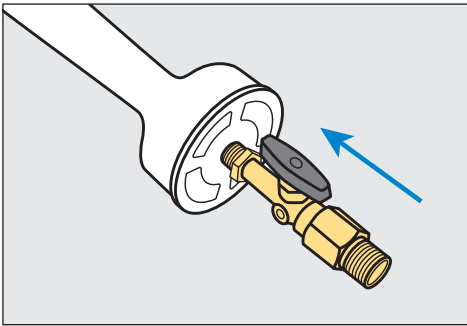

CONNECTION

Your appliance is designed to connect directly on to a POL gas cylinder using the specially designed LP Gas hose and regulator supplied with the appliance.

Check that the control knobs are in the OFF position (turned fully clockwise). See figure 2.

Take the stove connector head of the hose and attach to the gas inlet on the appliance, tighten up using fingers. See figure 3.

Attach the other end of the hose to the gas cylinder, tightening using a spanner. See figure 4.

Turn the cylinder gas valve on in an anti-clockwise direction for one full turn and then check the connections for leaks with Companion Gas Leak Detection Spray or soapy water. If a leak is detected turn the cylinder gas valve OFF and re-tighten all connections, then retest. See figure 5.

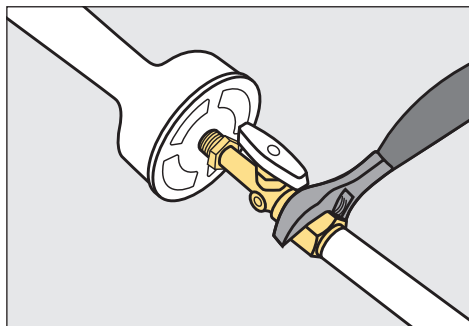

Figure 3

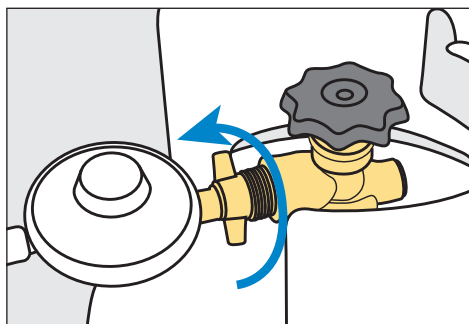

Figure 4

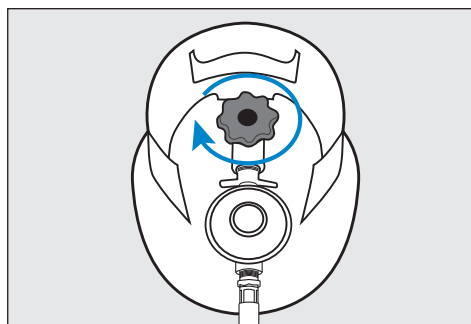

Figure 2

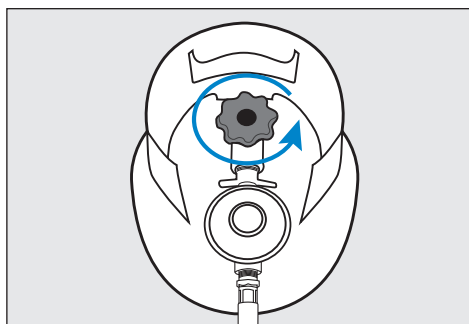

Figure 5



CHECKING FOR GAS LEAKS

Check that all connections are tight and that the gas cylinder connection has been tightened before you turn the cylinder gas valve on.

If there is a leak on your appliance (smell of gas) immediately attempt to turn off the cylinder valve. Remove the appliance to a well-ventilated location away from any ignition source.

NEVER check for leaks with a flame or pilot light.

Check for leaks using Companion Gas Leak Detection Spray or soapy water, coat all connections, if bubbles appear turn the cylinder gas control off and re-tighten the connection before re-testing.

SAFE LOCATIONS

This appliance shall only be used in an above ground open air situation with natural ventilation, without stagnant areas, where gas leakage and products of combustion are rapidly dispersed by wind and natural convection.

Any enclosure in which the appliance is used shall comply with one of the following:

An enclosure with walls on all sides, but with no overhead cover (see example 1).

Within a partial enclosure that includes an overhead cover and no more than two walls (see examples 2 & 3)

Within a partial enclosure that includes an overhead cover and more than two walls, the following shall apply:

At least 25% of the total wall area is completely open.

30% or more in total of the remaining wall side, back and front wall areas is open and unrestricted (see examples 4 & 5).

In the case of balconies, 20% or more of the total wall area shall remain open and unrestricted.

DIAGRAMMATIC REPRESENTATION OF OUTDOOR AREAS

The following examples are diagrammatic representations of outdoor areas. Rectangular areas have been used in these examples – the same principles apply to any other shaped area.

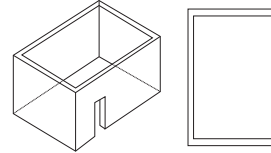

Example 1

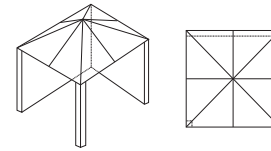

Example 2

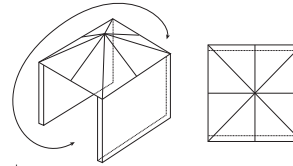

Both ends open

Example 3

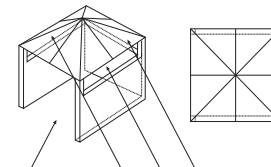

Open side at least 25% of total wall area.

30% or more in total of the remaining wall area is open and unrestricted.

Example 4

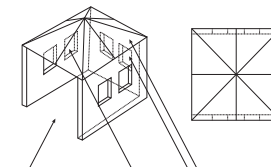

Open side at least 25% of total wall area.

30% or more in total of the remaining wall area is open and unrestricted.

Example 5



IMPORTANT INFORMATION FOR USE

During operation all surfaces will be extremely hot and should not be touched or handled.

Take care that the primary air intakes, located on the burner tube of this appliance are not obstructed, or that air flow is restricted by placing items or other appliances close to or adjacent to the inlets.

Do not attempt to move or relocate the appliance when it is operating, extinguish the burner and allow to cool, disengage the gas cylinder then move the appliance.

This appliance is to be stored in a dry and well-ventilated location free from direct sunlight. Do not store when still connected to the cylinder.

Make sure that the cylinder is disconnected and is stored in a well ventilated area, out of the reach of children, free from direct sunlight, heat and ignition sources. If being stored indoors, ensure that the location complies with the standard AS/NZS 1596.

Never leave appliance unattended when operating.

Do not use a multiple appliances to heat a single utensil.

Only use the 32cm cooking pot included in this kit with this appliance.

Do not use as a space heater.

Use as a cooking appliance only, is not to be used as heater or modify for any other reason.

Avoid boil over and spills on to burners.

After use, turn the gas cylinder valve off, wait for the flame to go out, then turn the appliance control valve(s) off.

Avoid twisting or kinking the flexible hose.

To check if gas remains in the cylinder, disconnect from the appliance and hold the cylinder in a vertical position then shake from side to side, if there is a sound or feel of liquid movement inside, the cylinder contains gas.



LIGHTING THE COOKER

Make sure the control knob is set to the OFF position.

Step 1. Turn the gas cylinder valve on, in an anti-clockwise direction for one full turn.

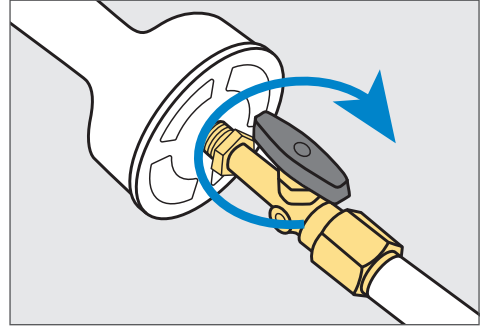
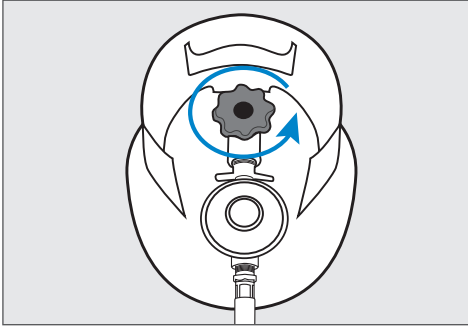

Step 2. Using long BBQ matches or gas lighter, position close to the edge of the burner, slowly turn the gas control in an anti-clockwise direction approximately $\frac{1}{4}$ of a turn.

Note: Locate the gas cylinder away from your cooker to ensure it is not subjected to radiant heat.

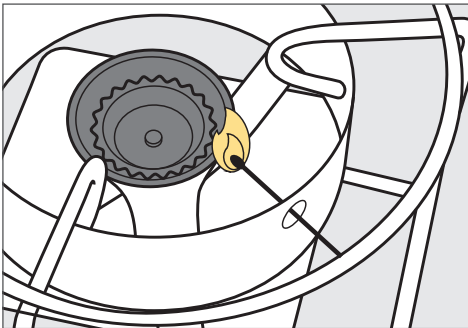



ADJUSTING HEAT OUTPUT

Turn the gas control in an anti-clockwise direction to achieve a higher flame and in the clockwise direction for a lower flame or to turn off

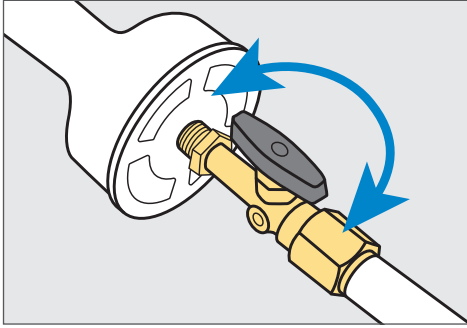

TURNING THE APPLIANCE OFF

If the appliance is no longer to be used and to reduce the risk of blocked gas jets caused by excess gas being left in the hose, all remaining gas must be expelled from the hose assembly.

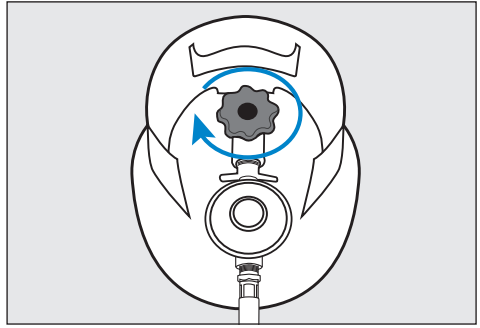

With the flame still operating, turn the valve on the gas cylinder in a clockwise direction until it is OFF. Allow the flame to burn down then extinguish once all remaining gas in the hose has been used.

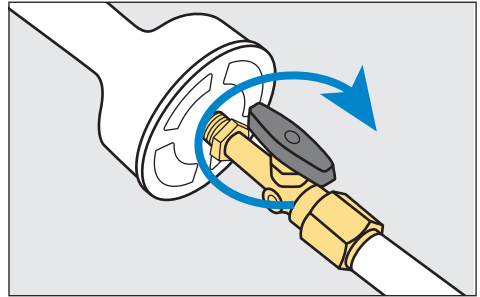

Turn the gas controls to the OFF position.



PACKING AND STORING

Step 1. Disconnect the LP gas hose from the Gas Control Assembly. The Gas Control Assembly does not need to be removed from the burner tube.

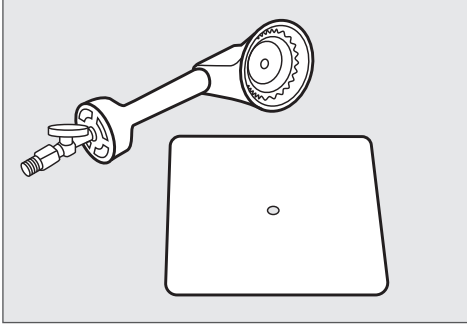

Step 2. Unscrew wing nut on base of burner. Remove reflector plate and burner assembly from cooker frame. Re-attach the wing nut to the burner.

Step 3. Place basket inside pot.

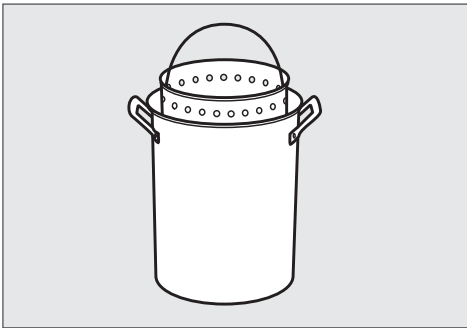

Step 4. Position cooker frame over pot and allow to slide inside.

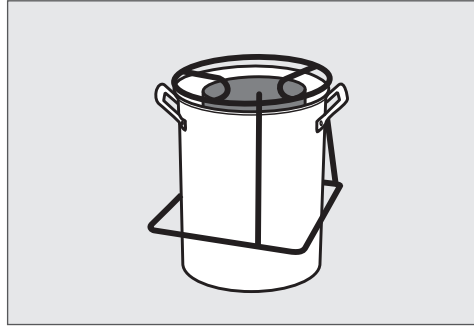

Step 5. Place burner, reflector plate, hose and regulator into the pot

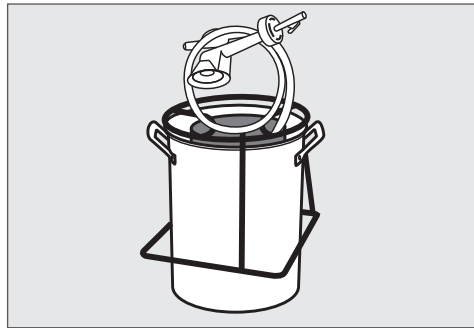

Step 6. Place lid on top before putting inside storage bag.

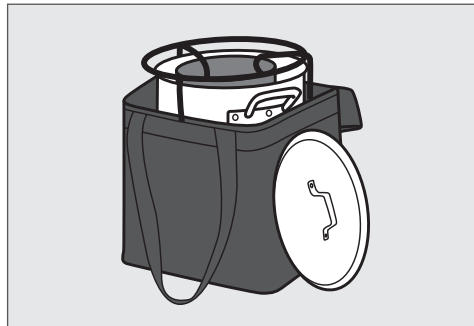

CARE INSTRUCTIONS

Using warm soapy water with a mild detergent wipe down all surfaces and areas of the appliance, taking care not to allow water to enter the burner outlets or aeration holes located in the burner tube.

Do not submerge the appliance in a sink or bowl.

Do not use abrasive cleaners or bleach.

MAINTENANCE AND SERVICE

During operation if it is noted that the burner flame is unstable, is changing colour from blue to yellow or has a distinct smell it is important that you take the appliance to your local authorised gas appliance repairer for inspection.

Periodically check the gas control is tight and has no leaks, follow the testing for leaks procedure. Check the gas hose for any signs of wear, cuts or fraying, if identified replace immediately with a Gas Certified replacement hose.

For further information or assistance please contact customer service.

A selection of spare parts and components are available for your appliance to ensure years of operation.

For more information in Australia call 1300 555 197 or email: service@companionbrands.com.au

For more information in New Zealand call 09 525 6667 or email: service@companionbrands.com.au

SPECIFICATIONS

Part no.	COMP7012
Model no.	Power Cooker & Stock Pot Set
Gas type	ULPG
Gas jet size	1.02mm
Gas consumption	Medium: 90MJ/h - 1786g/h
BTU output (total)	85,300 BTU
Inlet pressure	Cylinder Pressure
Dimensions	350L x 350W x 437H mm
Weight	7.51kg
Certificate number	AGA 8389 G

SPARE PARTS LIST

SGB04-01	Burner Assembly
SGB04-02	Gas Control Assembly
SGB04-03	Hose/Reg Assembly
SGB04-04	Thermometer
SGB04-05	Heat Diffuser Plate



NOTES



Designed & Imported by:
Adventure Trading Australia Pty Ltd
www.companionleisure.com.au

Distributed in New Zealand by:
Gladiator Sports Ltd

COM5291